



**TRANE®**

# Upflow/Horizontal Right or Upflow/Horizontal Left Induced Draft Gas Furnace

## XR 80

TUD1A040A9241A, TUD1A040A9301A, TUD1A060A9241A,  
TUD1A060A9361A, TUD1B060A9361A, TUD1B080A9241A,  
TUD1B080A9361A, TUD1B080A9481A, TUD1C080A9601A,  
TUD1B100A9361A, TUD1B100A9451A, TUD1C100A9481A,  
TUD1C100A9601A, TUD1D100A9721A, TUD1C120A9541A,  
TUD1D120A9601A, TUD1D140A9601A

Single-Stage Fan Assisted  
Combustion System

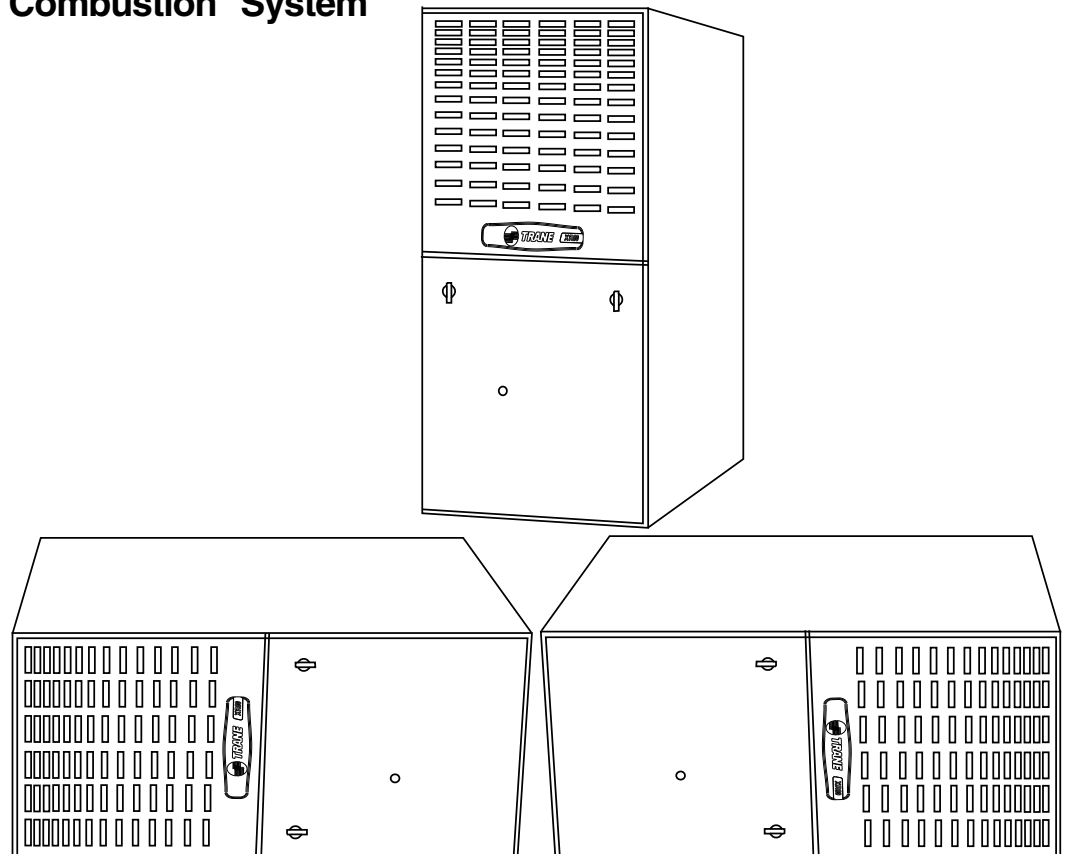

**PUB. NO. 22-1640-12**



**TRANE®**

# General Features

---

## **NATURAL GAS MODELS**

Central Heating furnace designs are certified by the American and Canadian Gas Associations for both natural and L.P. gas. Limit setting and rating data were established and approved under standard rating conditions using American National Standards Institute standards.

## **SAFE OPERATION**

The Integrated System Control has solid state devices, which continuously monitor for presence of flame, when the system is in the heating mode of operation. Dual solenoid combination gas valve and regulator provide extra safety.

## **QUICK HEATING**

Durable, cycle tested, heavy gauge **aluminized steel heat exchanger** quickly transfers heat to provide warm conditioned air to the structure.

## **BURNERS**

Multiport Inshot burners will give years of quiet and efficient service. All models can be converted to **L.P. gas**.

## **INTEGRATED SYSTEM CONTROL**

Exclusively designed operational program provides total control of furnace limit sensors, blowers, gas valve, flame control and includes self diagnostics for ease of service. Also contains connection points for E.A.C./humidifier.

## **AIR DELIVERY**

The 4-speed, direct drive blower motor, has sufficient airflow for most heating and cooling requirements, will switch from heating to cooling speeds on demand from room thermostat. The blower door safety switch will prevent or terminate furnace operation when the blower door is removed.

## **STYLING**

**Heavy gauge steel and “wrap-around” cabinet construction** is used in the cabinet with baked-on enamel finish for strength and beauty. The heat exchanger section of the cabinet is completely lined with foil faced fiberglass insulation. This results in quiet and efficient operation due to the excellent acoustical and insulating qualities of fiberglass.

## **FEATURES AND GENERAL OPERATION**

The XR 80 High Efficiency Gas Furnaces employs an adaptive Hot Surface Ignition system, which eliminates the waste of a constant burning pilot. The integrated system control lights the main burners upon a demand for heat from the room thermostat. Complete front service access.

- a. Low energy power venter
- b. Vent proving pressure switch.



# Contents

---

<b>General Features</b>	<b>2</b>
<b>Features and Benefits</b>	<b>4</b>
Standard Equipment	4
Optional Equipment	4
<b>General Data</b>	<b>5</b>
TUD1A040A9241A	5
TUD1A040A9301A	5
TUD1A060A9241A	6
TUD1A060A9361A	6
TUD1B060A9361A	6
TUD1B080A9241A	7
TUD1B080A9361A	7
TUD1B080A9481A	7
TUD1C080A9601A	7
TUD1B100A9361A	8
TUD1B100A9451A	8
TUD1C100A9481A	8
TUD1C100A9601A	8
TUD1D100A9721A	9
TUD1C120A9541A	9
TUD1D120A9601A	9
TUD1D140A9601A	9
<b>Performance Data</b>	<b>10</b>
<b>Field Wiring</b>	<b>12</b>
<b>Dimensions</b>	<b>14</b>
<b>Electrical Data</b>	<b>15</b>



# Features and Benefits

## XR 80 UPFLOW/HORIZONTAL RIGHT or LEFT STANDARD EQUIPMENT

- Power supply 115/1/60
- Multi-port In-shot burners
- Integrated solid state control with self diagnostics
- Silicon Nitride hot surface igniter with adaptive heat up
- Complete front service access
- Heavy guage aluminized steel heat exchanger
- Slide out blower assembly
- Blower door safety switch
- Direct drive, 4-speed motor
- Optional L.P. conversion kit
- Common vent
- Alternate bottom/left/right return air
- Hinged blower door
- Perfect Fit door latches
- Gasketed blower door
- Single wire twinning
- Selectable cooling fan off delay
- Left-right gas connection
- Optional L.P. conversion kit
- Common vent capability
- 24 volt fuse
- Manual reset flame roll out switches
- Insulated blower door
- Insulated blower compartment
- Accessory hook-up capability - Hum and EAC
- Blower door safety switch

## XR 80 OPTIONAL EQUIPMENT

Thermostat .....	BAYSTAT388 [ ]
Thermostat, Heating/Cooling Single Stage (Mounts Horizontally) .....	AY28X092 [ ]
Thermostat, Heating/Cooling Single Stage (Mounts Vertically) .....	BAYSTAT305 [ ]
Thermostat, Electronic Programmable 1-Stage Heating/1-Stage Cooling .....	TAYSTAT300C [ ]
Propane Conversion Kit .....	BAYLPKT210A [ ]
Electronic Air Filter, "Perfect Fit" High Efficiency (14-1/2" Wide Gas Furnace) .....	TFM145A9FR1 [ ]
Electronic Air Filter, "Perfect Fit" High Efficiency (17-1/2" Wide Gas Furnace) .....	TFM175A9FR1 [ ]
Electronic Air Filter, "Perfect Fit" High Efficiency (21" Wide Gas Furnace) .....	TFM210A9FR1 [ ]
Electronic Air Filter, "Perfect Fit" High Efficiency (24-1/2" Wide Gas Furnace) .....	TFM245A9FR1 [ ]
Electronic Air Filter, "Perfect Fit" Standard Efficiency (17-1/2" Wide Gas Furnace) .....	TFP175A9FR01 [ ]
Electronic Air Filter, "Perfect Fit" Standard Efficiency (21" Wide Gas Furnace) .....	TFP210A9FR01 [ ]
Electronic Air Filter, "Perfect Fit" Standard Efficiency (24-1/2" Wide Gas Furnace) .....	TFP245A9FR01 [ ]
Coil Enclosure (14-1/2" Wide Cabinets) .....	BAYCLE14A1422A [ ]
Coil Enclosure (17-1/2" Wide Cabinets) .....	BAYCLE17A1722A [ ]
Coil Enclosure (21" Wide Cabinets) .....	BAYCLE21A2130A [ ]
Coil Enclosure (24-1/2" Wide Cabinets) .....	BAYCLE24A2430A [ ]
High Altitude Pressure Switch Kit .....	BAYHALT248 [ ]
Masonry Chimney Vent Kit (Upflow models only) .....	BAYVENT800B [ ]
Filter Rack Kit .....	BAYRACK960A [ ]



# General Data

## PRODUCT SPECIFICATIONS ①

MODEL	TUD1A040A9241A	TUD1A060A9241A	TUD1A040A9301A
<b>TYPE</b>	Upflow / Horizontal	Upflow / Horizontal	Upflow / Horizontal
<b>RATINGS ②</b>			
Input BTUH	40,000	60,000	40,000
Capacity BTUH (ICS) ③	32,000	47,000	32,000
AFUE	80.0	80.0	80.0
Temp. rise (Min.-Max.) °F.	30 - 60	35 - 65	30 - 60
<b>BLOWER DRIVE</b>	DIRECT	DIRECT	DIRECT
Diameter - Width (In.)	10 x 6	10 x 6	10 x 6
No. Used	1	1	1
Speeds (No.)	4	4	4
CFM vs. in. w.g.	See Fan Performance Table	See Fan Performance Table	See Fan Performance Table
Motor HP	1/5	1/5	1/3
R.P.M.	1080	1080	1075
Volts / Ph / Hz	115/1/60	115/1/60	115/1/60
<b>COMBUSTION FAN - Type</b>	Centrifugal	Centrifugal	Centrifugal
Drive - No. Speeds	Direct - 1	Direct - 1	Direct - 1
Motor HP - RPM	1/50 - 3000	1/50 - 3000	1/50 - 3000
Volts / Ph / Hz	115/1/60	115/1/60	115/1/60
ELA	1.0	1.0	1.0
<b>FILTER — Furnished?</b>	No	No	No
Type Recommended	High Velocity	High Velocity	High Velocity
Hi Vel. (No.-Size-Thk.)	1 - 16x25 - 1in.	1 - 16x25 - 1in.	1 - 16x25 - 1in.
<b>VENT — Size (in.)</b>	4 Round	4 Round	4 Round
<b>HEAT EXCHANGER</b>			
Type-Fired	Aluminized Steel - Type I	Aluminized Steel - Type I	Aluminized Steel - Type I
-Unfired			
Gauge (Fired)	20	20	20
<b>ORIFICES — Main</b>			
Nat. Gas. Qty. — Drill Size	2 — 45	3 — 45	2 — 45
L.P. Gas Qty. — Drill Size	2 — 56	3 — 56	2 — 56
<b>GAS VALVE</b>	Redundant - Single Stage	Redundant - Single Stage	Redundant - Single Stage
<b>PILOT SAFETY DEVICE</b>			
Type	Hot Surface Ignition	Hot Surface Ignition	Hot Surface Ignition
<b>BURNERS — Type</b>	Multiport Inshot	Multiport Inshot	Multiport Inshot
Number	2	3	2
<b>POWER CONN. — V / Ph / Hz ④</b>	115/1/60	115/1/60	115/1/60
Ampacity (In Amps)	6.3	10.4	6.3
Max Overcurrent Protection (Amps)	15	15	15
<b>PIPE CONN. SIZE (IN.)</b>	1/2	1/2	1/2
<b>DIMENSIONS</b>	H x W x D	H x W x D	H x W x D
Crated (In.)	41-3/4 x 16-1/2 x 30-1/2	41-3/4 x 16-1/2 x 30-1/2	41-3/4 x 16-1/2 x 30-1/2
<b>WEIGHT</b>			
Shipping (Lbs.) / Net (Lbs)	119 / 110	124 / 115	122 / 113

① Central Furnace heating designs are certified by AGA and CSA.

② For U.S. applications, above input ratings (BTUH) are up to 2,000 feet, derate 4% per 1,000 feet for elevations above 2,000 feet above sea level. For Canadian applications, above input ratings (BTUH) are up to 4,500 feet, derate 4% per 1,000 feet for elevations above 4,500 feet above sea level.

③ Based on U.S. government standard tests.

④ The above wiring specifications are in accordance with National Electrical Code; however, installations must comply with local codes.



# General Data

## PRODUCT SPECIFICATIONS ①

MODEL	TUD1A060A9361A	TUD1B060A9361A	TUD1B080A9241A
TYPE	Upflow / Horizontal	Upflow / Horizontal	Upflow / Horizontal
<b>RATINGS ②</b>			
Input BTUH	60,000	60,000	80,000
Capacity BTUH (ICS) ③	47,000	47,000	64,000
AFUE	80.0	80.0	80.0
Temp. rise (Min.-Max.) °F.	30 - 60	30 - 60	50 - 80
<b>BLOWER DRIVE</b>			
	DIRECT	DIRECT	DIRECT
Diameter - Width (In.)	10 x 6	10 x 7	9 x 7
No. Used	1	1	1
Speeds (No.)	4	4	4
CFM vs. in. w.g.	See Fan Performance Table	See Fan Performance Table	See Fan Performance Table
Motor HP	1/3	1/3	1/5
R.P.M.	1075	1075	1080
Volts / Ph / Hz	115/1/60	115/1/60	115/1/60
<b>COMBUSTION FAN - Type</b>			
	Centrifugal	Centrifugal	Centrifugal
Drive - No. Speeds	Direct - 1	Direct - 1	Direct - 1
Motor HP - RPM	1/50- 3000	1/50- 3000	1/50- 3000
Volts / Ph / Hz	115/1/60	115/1/60	115/1/60
FLA	1.0	1.0	1.0
<b>FILTER — Furnished?</b>			
	No	No	No
Type Recommended	High Velocity	High Velocity	High Velocity
Hi Vel. (No.-Size-Thk.)	1 - 16x25 - 1in.	1 - 17x25 - 1in.	1 - 17x25 - 1in.
<b>VENT — Size (in.)</b>			
	4 Round	4 Round	4 Round
<b>HEAT EXCHANGER</b>			
Type-Fired	Aluminized Steel - Type I	Aluminized Steel - Type I	Aluminized Steel - Type I
-Unfired			
Gauge (Fired)	20	20	20
<b>ORIFICES — Main</b>			
Nat. Gas Qty. — Drill Size	3 — 45	3 — 45	4 — 45
L.P. Gas Qty. — Drill Size	3 — 56	3 — 56	4 — 56
<b>GAS VALVE</b>			
	Redundant - Single Stage	Redundant - Single Stage	Redundant - Single Stage
<b>PILOT SAFETY DEVICE</b>			
Type	Hot Surface Ignition	Hot Surface Ignition	Hot Surface Ignition
<b>BURNERS — Type</b>			
	Multiport Inshot	Multiport Inshot	Multiport Inshot
Number	3	3	4
<b>POWER CONN. — V / Ph / Hz ④</b>			
	115/1/60	115/1/60	115/1/60
Ampacity (In Amps)	9.0	9.0	10.4
Max Overcurrent Protection (Amps)	15	15	15
<b>PIPE CONN. SIZE (IN.)</b>			
	1/2	1/2	1/2
<b>DIMENSIONS</b>			
	H x W x D	H x W x D	H x W x D
Crated (In.)	41-3/4 x 16-1/2 x 30-1/2	41-3/4 x 19-1/2 x 30-1/2	41-3/4 x 19-1/2 x 30-1/2
<b>WEIGHT</b>			
Shipping (Lbs.) / Net (Lbs)	127 / 118	137 / 127	139 / 129

① Central Furnace heating designs are certified by AGA and CSA.

② For U.S. applications, above input ratings (BTUH) are up to 2,000 feet, derate 4% per 1,000 feet for elevations above 2,000 feet above sea level. For Canadian applications, above input ratings (BTUH) are up to 4,500 feet, derate 4% per 1,000 feet for elevations above 4,500 feet above sea level.

③ Based on U.S. government standard tests.

④ The above wiring specifications are in accordance with National Electrical Code; however, installations must comply with local codes.



# General Data

## PRODUCT SPECIFICATIONS ①

MODEL	TUD1B080A9361A	TUD1B080A9481A	TUD1C080A9601A
<b>TYPE</b>	Upflow / Horizontal	Upflow / Horizontal	Upflow / Horizontal
<b>RATINGS ②</b>			
Input BTUH	80,000	80,000	80,000
Capacity BTUH (ICS) ③	63,000	64,000	64,000
AFUE	80.0	80.0	80.0
Temp. rise (Min.-Max.) °F.	30 - 60	30 - 60	25 - 55
<b>BLOWER DRIVE</b>	DIRECT	DIRECT	DIRECT
Diameter - Width (In.)	10 x 7	10 x 8	11 x 10
No. Used	1	1	1
Speeds (No.)	4	4	4
CFM vs. in. w.g.	See Fan Performance Table	See Fan Performance Table	See Fan Performance Table
Motor HP	1/3	1/3	3/4
R.P.M.	1075	1075	1100
Volts / Ph / Hz	115/1/60	115/1/60	115/1/60
<b>COMBUSTION FAN - Type</b>	Centrifugal	Centrifugal	Centrifugal
Drive - No. Speeds	Direct - 1	Direct - 1	Direct - 1
Motor HP - RPM	1/50- 3000	1/50- 3000	1/50- 3000
Volts / Ph / Hz	115/1/60	115/1/60	115/1/60
FLA	1.0	1.0	1.0
<b>FILTER — Furnished?</b>	No	No	No
Type Recommended	High Velocity	High Velocity	High Velocity
Hi Vel. (No.-Size-Thk.)	1 - 17x25 - 1in.	1 - 17x25 - 1in.	1 - 20x25 - 1in.
<b>VENT — Size (in.)</b>	4 Round	4 Round	4 Round
<b>HEAT EXCHANGER</b>			
Type-Fired	Aluminized Steel - Type I	Aluminized Steel - Type I	Aluminized Steel - Type I
-Unfired			
Gauge (Fired)	20	20	20
<b>ORIFICES — Main</b>			
Nat. Gas. Qty. — Drill Size	4 — 45	4 — 45	4 — 45
L.P. Gas Qty. — Drill Size	4 — 56	4 — 56	4 — 56
<b>GAS VALVE</b>	Redundant - Single Stage	Redundant - Single Stage	Redundant - Single Stage
<b>PILOT SAFETY DEVICE</b>			
Type	Hot Surface Ignition	Hot Surface Ignition	Hot Surface Ignition
<b>BURNERS — Type</b>	Multiport Inshot	Multiport Inshot	Multiport Inshot
Number	4	4	4
<b>POWER CONN. — V / Ph / Hz ④</b>	115/1/60	115/1/60	115/1/60
Ampacity (In Amps)	10.4	9.1	13.8
Max Overcurrent Protection (Amps)	15	15	15
<b>PIPE CONN. SIZE (IN.)</b>	1/2	1/2	1/2
<b>DIMENSIONS</b>	H x W x D	H x W x D	H x W x D
Crated (In.)	41-3/4 x 19-1/2 x 30-1/2	41-3/4 x 19-1/2 x 30-1/2	41-3/4 x 23 x 30-1/2
<b>WEIGHT</b>			
Shipping (Lbs.) / Net (Lbs)	142 / 132	142 / 132	162 / 151

②



**TRANE®**

# General Data

## PRODUCT SPECIFICATIONS ①

MODEL	TUD1B100A9361A	TUD1B100A9451A	TUD1C100A9481A	TUD1C100A9601A
<b>TYPE</b>	Upflow / Horizontal	Upflow / Horizontal	Upflow / Horizontal	Upflow / Horizontal
<b>RATINGS ②</b>				
Input BTUH	100,000	100,000	100,000	100,000
Capacity BTUH (ICS) ③	79,000	79,000	79,000	79,000
AFUE	80.0	80.0	80.0	80.0
Temp. rise (Min.-Max.) °F.	40 - 70	35 - 65	35 - 65	30 - 60
<b>BLOWER DRIVE</b>				
	DIRECT	DIRECT	DIRECT	DIRECT
Diameter - Width (In.)	10 x 7	10 x 8	10 x 8	11 x 10
No. Used	1	1	1	1
Speeds (No.)	4	4	4	4
CFM vs. in. w.g.	See Fan Performance Table	See Fan Performance Table	See Fan Performance Table	See Fan Performance Table
Motor HP	1/3	1/3	1/2	1/2
R.P.M.	1075	1075	1075	1075
Volts / Ph / Hz	115/1/60	115/1/60	115/1/60	115/1/60
<b>COMBUSTION FAN - Type</b>				
	Centrifugal	Centrifugal	Centrifugal	Centrifugal
Drive - No. Speeds	Direct - 1	Direct - 1	Direct - 1	Direct - 1
Motor HP - RPM	1/50- 3000	1/50- 3000	1/50- 3000	1/50- 3000
Volts / Ph / Hz	115/1/60	115/1/60	115/1/60	115/1/60
FLA	1.0	1.0	1.0	1.0
<b>FILTER — Furnished?</b>				
	No	No	No	No
Type Recommended	High Velocity	High Velocity	High Velocity	High Velocity
Hi Vel. (No.-Size-Thk.)	1 - 17x25 - 1in.	1 - 17x25 - 1in.	1 - 20x25 - 1in.	1 - 20x25 - 1in.
<b>VENT — Size (in.)</b>				
	4 Round	4 Round	4 Round	4 Round
<b>HEAT EXCHANGER</b>				
Type-Fired	Aluminized Steel - Type I	Aluminized Steel - Type I	Aluminized Steel - Type I	Aluminized Steel - Type I
-Unfired				
Gauge (Fired)	20	20	20	20
<b>ORIFICES — Main</b>				
Nat. Gas. Qty. — Drill Size	5 — 45	5 — 45	5 — 45	5 — 45
L.P. Gas Qty. — Drill Size	5 — 56	5 — 56	5 — 56	5 — 56
<b>GAS VALVE</b>				
	Redundant - Single Stage	Redundant - Single Stage	Redundant - Single Stage	Redundant - Single Stage
<b>PILOT SAFETY DEVICE</b>				
Type	Hot Surface Ignition	Hot Surface Ignition	Hot Surface Ignition	Hot Surface Ignition
<b>BURNERS — Type</b>				
	Multiport Inshot	Multiport Inshot	Multiport Inshot	Multiport Inshot
Number	5	5	5	5
<b>POWER CONN. — V / Ph / Hz ④</b>				
	115/1/60	115/1/60	115/1/60	115/1/60
Ampacity (In Amps)	10.4	10.4	11.6	12.8
Max Overcurrent Protection (Amps)	15	15	15	15
<b>PIPE CONN. SIZE (IN.)</b>				
	1/2	1/2	1/2	1/2
<b>DIMENSIONS</b>				
	H x W x D	H x W x D	H x W x D	H x W x D
Crated (In.)	41-3/4 x 19-1/2 x 30-1/2	41-3/4 x 19-1/2 x 30-1/2	41-3/4 x 23 x 30-1/2	41-3/4 x 23 x 30-1/2
<b>WEIGHT</b>				
Shipping (Lbs.) / Net (Lbs)	151 / 141	153 / 143	162 / 151	162 / 151

① Central Furnace heating designs are certified by AGA and CSA.

② For U.S. applications, above input ratings (BTUH) are up to 2,000 feet, derate 4% per 1,000 feet for elevations above 2,000 feet above sea level. For Canadian applications, above input ratings (BTUH) are up to 4,500 feet, derate 4% per 1,000 feet for elevations above 4,500 feet above sea level.

③ Based on U.S. government standard tests.

④ The above wiring specifications are in accordance with National Electrical Code; however, installations must comply with local codes.





# General Data

## PRODUCT SPECIFICATIONS ①

MODEL	TUD1D100A9721A	TUD1C120A9541A	TUD1D120A9601A	TUD1D140A9601A
<b>TYPE</b>	Upflow / Horizontal	Upflow / Horizontal	Upflow / Horizontal	Upflow / Horizontal
<b>RATINGS ②</b>				
Input BTUH	100,000	120,000	120,000	140,000
Capacity BTUH (ICS) ③	80000	96,000	96,000	111,000
AFUE	80.0	80.0	80.0	80.0
Temp. rise (Min.-Max.) °F.	30 - 60	35 - 65	30 - 60	40 - 70
<b>BLOWER DRIVE</b>	DIRECT	DIRECT	DIRECT	DIRECT
Diameter - Width (In.)	11 x 10	11 x 10	11 x 10	11 x 10
No. Used	1	1	1	1
Speeds (No.)	4	4	4	4
CFM vs. in. w.g.	See Fan Performance Table	See Fan Performance Table	See Fan Performance Table	See Fan Performance Table
Motor HP	3/4	1/2	1/2	3/4
R.P.M.	1100	1075	1075	1075
Volts / Ph / Hz	115/1/60	115/1/60	115/1/60	115/1/60
<b>COMBUSTION FAN - Type</b>	Centrifugal	Centrifugal	Centrifugal	Centrifugal
Drive - No. Speeds	Direct - 1	Direct - 1	Direct - 1	Direct - 1
Motor HP - RPM	1/50 - 3000	1/50 - 3000	1/50 - 3000	1/50 - 3000
Volts / Ph / Hz	115/1/60	115/1/60	115/1/60	115/1/60
FLA	1.0	1.0	1.0	1.0
<b>FILTER — Furnished?</b>	No	No	No	No
Type Recommended	High Velocity	High Velocity	High Velocity	High Velocity
Hi Vel. (No.-Size-Thk.)	1 - 24x25 - 1in.	1 - 20x25 - 1in.	1 - 24x25 - 1in.	1 - 24x25 - 1in.
<b>VENT — Size (in.)</b>	4 Round	4 Round	4 Round	4 Round
<b>HEAT EXCHANGER</b>				
Type-Fired	Aluminized Steel - Type I	Aluminized Steel - Type I	Aluminized Steel - Type I	Aluminized Steel - Type I
-Unfired				
Gauge (Fired)	20	20	20	20
<b>ORIFICES — Main</b>				
Nat. Gas Qty. — Drill Size	5 — 45	6 — 45	6 — 45	7 — 45
L.P. Gas Qty. — Drill Size	5 — 56	6 — 56	6 — 56	7 — 56
<b>GAS VALVE</b>	Redundant - Single Stage	Redundant - Single Stage	Redundant - Single Stage	Redundant - Single Stage
<b>PILOT SAFETY DEVICE</b>				
Type	Hot Surface Ignition	Hot Surface Ignition	Hot Surface Ignition	Hot Surface Ignition
<b>BURNERS — Type</b>	Multiport Inshot	Multiport Inshot	Multiport Inshot	Multiport Inshot
Number	5	6	6	7
<b>POWER CONN. — V / Ph / Hz ④</b>	115/1/60	115/1/60	115/1/60	115/1/60
Ampacity (In Amps)	13.1	12.8	12.8	13.1
Max Overcurrent Protection (Amps)	15	15	15	15
<b>PIPE CONN. SIZE (IN.)</b>	1/2	1/2	1/2	1/2
<b>DIMENSIONS</b>	H x W x D	H x W x D	H x W x D	H x W x D
Crated (In.)	41-3/4 x 26-1/2 x 30-1/2	41-3/4 x 23 x 30-1/2	41-3/4 x 26-1/2 x 30-1/2	41-3/4 x 26-1/2 x 30-1/2
<b>WEIGHT</b>				
Shipping (Lbs.) / Net (Lbs)	175 / 163	176 / 164	186 / 174	193 / 181

① Central Furnace heating designs are certified by AGA and CSA.

② For U.S. applications, above input ratings (BTUH) are up to 2,000 feet, derate 4% per 1,000 feet for elevations above 2,000 feet above sea level. For Canadian applications, above input ratings (BTUH) are up to 4,500 feet, derate 4% per 1,000 feet for elevations above 4,500 feet above sea level.

③ Based on U.S. government standard tests.

④ The above wiring specifications are in accordance with National Electrical Code; however, installations must comply with local codes.



**TRANE®**

# Performance Data

FURNACE AIRFLOW (CFM) VS. STATIC PRESSURE (ins. w.g.)										
MODEL	SPEED TAP	0.10	0.20	0.30	0.40	0.50	0.60	0.70	0.80	0.90
TUD1A040A9241A	4 - HIGH - Black	1018	1004	982	950	910	860	802	763	660
	3 - MED.-HIGH - Blue	847	832	809	779	742	697	644	585	517
	2 - MED.-LOW - Yellow	716	701	678	648	610	585	512	452	384
	1 - LOW - Red	617	599	575	544	507	463	413	357	294
TUD1A040A9301A	4 - HIGH - Black	1307	1262	1211	1164	1092	1023	949	869	783
	3 - MED.-HIGH - Blue	1172	1140	1100	1053	996	937	867	791	707
	2 - MED.-LOW - Yellow	1030	1007	976	938	893	840	779	712	636
	1 - LOW - Red	892	876	856	893	789	744	691	630	561
TUD1A060A9241A	4 - HIGH - Black	1013	997	973	941	901	852	796	731	659
	3 - MED.-HIGH - Blue	835	821	800	771	734	689	636	575	506
	2 - MED.-LOW - Yellow	712	702	683	655	617	571	516	452	379
	1 - LOW - Red	611	596	573	543	505	459	406	345	277
TUD1A060A9361A	4 - HIGH - Black	1426	1389	1345	1298	1236	1171	1099	1020	934
	3 - MED.-HIGH - Blue	1243	1225	1197	1160	1113	1057	991	916	831
	2 - MED.-LOW - Yellow	1042	1039	1027	1005	973	931	879	817	745
	1 - LOW - Red	900	903	895	877	848	809	760	700	629
TUD1B060A9361A	4 - HIGH - Black	1588	1554	1517	1468	1412	1351	1278	1200	1102
	3 - MED.-HIGH - Blue	1329	1318	1299	1268	1228	1186	1135	1072	988
	2 - MED.-LOW - Yellow	1090	1090	1093	1076	1052	1028	978	917	836
	1 - LOW - Red	894	901	904	894	881	860	828	777	683
TUD1B080A9241A	4 - HIGH - Black	1115	1094	1060	1014	956	886	803	708	600
	3 - MED.-HIGH - Blue	919	912	891	857	809	747	671	582	478
	2 - MED.-LOW - Yellow	772	767	750	722	681	629	565	489	401
	1 - LOW - Red	643	655	648	622	577	512	428	325	203
TUD1B080A9361A	4 - HIGH - Black	1393	1384	1364	1335	1296	1247	1189	1120	1042
	3 - MED.-HIGH - Blue	1210	1209	1198	1177	1147	1107	1058	999	930
	2 - MED.-LOW - Yellow	1046	1052	1047	1033	1008	963	928	873	808
	1 - LOW - Red	900	903	895	888	869	842	808	766	717
TUD1B080A9481A	4 - HIGH - Black	1839	1821	1796	1756	1710	1641	1573	1480	1392
	3 - MED.-HIGH - Blue	1323	1325	1329	1319	1308	1275	1246	1201	1165
	2 - MED.-LOW - Yellow	1092	1090	1091	1083	1076	1059	1040	1005	970
	1 - LOW - Red	788	783	780	768	758	737	719	647	630
TUD1C080A9601A	4 - HIGH - Black	2308	2281	2254	2209	2163	2095	2026	1950	1873
	3 - MED.-HIGH - Blue	2006	1997	1987	1960	1933	1888	1842	1780	1718
	2 - MED.-LOW - Yellow	1690	1691	1691	1683	1674	1651	1627	1556	1485
	1 - LOW - Red	1437	1437	1437	1434	1431	1418	1404	1369	1334
TUD1B100A9361A	4 - HIGH - Black	1476	1464	1441	1408	1363	1307	1241	1163	1074
	3 - MED.-HIGH - Blue	1249	1257	1252	1234	1203	1158	1101	1030	946
	2 - MED.-LOW - Yellow	1020	1046	1058	1050	1028	990	936	866	780
	1 - LOW - Red	873	887	890	883	864	834	794	742	680
TUD1B100A9451A	4 - HIGH - Black	1771	1731	1355	1624	1556	1479	1392	1296	1191
	3 - MED.-HIGH - Blue	1375	1371	1328	1328	1289	1238	1176	1102	1016
	2 - MED.-LOW - Yellow	1127	1141	1124	1124	1094	1049	989	914	825
	1 - LOW - Red	780	815	829	822	796	749	681	593	485
TUD1C100A9481A	4 - HIGH - Black	1880	1846	1799	1740	1669	1595	1489	1381	1260
	3 - MED.-HIGH - Blue	1662	1635	1598	1551	1493	1424	1345	1256	1157
	2 - MED.-LOW - Yellow	1428	1421	1402	1370	1326	1269	1199	1117	1022
	1 - LOW - Red	1208	1215	1210	1193	1164	1124	1073	1009	935
TUD1C100A9601A	4 - HIGH - Black	2181	2143	2104	2053	2001	1929	1856	1766	1676
	3 - MED.-HIGH - Blue	1908	1888	1868	1834	1800	1745	1690	1631	1572
	2 - MED.-LOW - Yellow	1621	1609	1597	1582	1567	1533	1498	1438	1377
	1 - LOW - Red	1443	1419	1395	1381	1367	1335	1302	1256	1209



# Performance Data

FURNACE AIRFLOW (CFM) VS. STATIC PRESSURE (ins. w.g.)										
MODEL	SPEED TAP	0.10	0.20	0.30	0.40	0.50	0.60	0.70	0.80	0.90
TUD1D100A9721A BOTTOM AND LEFT SIDE RETURN	4 - HIGH - Black 3 - MED.-HIGH - Blue 2 - MED.-LOW - Yellow 1 - LOW - Red	2484	2458	2432	2387	2342 SEE NOTE 1	2275	2208	2125	2041
TUD1D100A9721A	4 - HIGH - Black 3 - MED.-HIGH - Blue 2 - MED.-LOW - Yellow 1 - LOW - Red	2447 2097 1753 1459	2401 2088 1750 1456	2356 2079 1748 1453	2303 2053 1732 1443	2249 2028 1716 1434	2173 1970 1690 1407	2097 1912 1665 1380	1994 1831 1594 1335	1892 1750 1523 1289
TUD1C120A9541A	4 - HIGH - Black 3 - MED.-HIGH - Blue 2 - MED.-LOW - Yellow 1 - LOW - Red	2162 1889 1654 1427	2130 1881 1643 1421	2097 1873 1631 1414	2067 1839 1619 1400	2037 1805 1606 1386	1976 1776 1572 1357	1914 1746 1538 1327	1833 1670 1483 1285	1752 1593 1428 1243
TUD1D120A9601A	4 - HIGH - Black 3 - MED.-HIGH - Blue 2 - MED.-LOW - Yellow 1 - LOW - Red	2135 1906 1646 1423	2101 18814 1632 1415	2066 1856 1617 1407	2036 1817 1596 1391	2005 1777 1575 1375	1923 1724 1535 1338	1840 1671 1494 1300	1750 1602 1427 1246	1659 1533 1360 1192
TUD1D140A9601A	4 - HIGH - Black 3 - MED.-HIGH - Blue 2 - MED.-LOW - Yellow 1 - LOW - Red	2462 2128 1755 1450	2407 2112 1746 1446	2351 2096 1736 1442	2284 2054 1719 1427	2216 2054 1702 1411	2143 2011 1656 1383	2069 1887 1609 1354	1989 1797 1564 1298	1908 1706 1518 1241

**Note 1:** High speed CFM is based on bottom and left side return option for this model. Medium High, Medium Low, and Low speedtaps for this model do not have improved airflow with the addition of side return.

CFM VS. TEMPERATURE RISE																							
MODEL	Cubic Feet Per Minute (CFM)																						
	500	600	700	800	900	1000	1100	1200	1300	1400	1500	1600	1700	1800	1900	2000	2100	2200	2300	2400			
TUD1A040A9241A	59	49	42	37	33	30																	
TUD1A040A9301A	59	49	42	37	33																		
TUD1A060A9241A			63	56	49	44																	
TUD1A060A9361A				56	49	44	40	37	34	32													
TUD1B060A9361A				56	49	44	40	37	34	32													
TUD1B080A9241A				74	66	59	54																
TUD1B080A9361A						59	54	49	46	42													
TUD1B080A9481A						59	54	49	46	42	40	37	35	33									
TUD1C080A9601A							54	49	46	42	40	37	35	33	31	30	28	27	26				
TUD1B100A9361A							67	62	57	53	49												
TUD1B100A9451A								62	57	53	49	46	44	41									
TUD1C100A9481A							67	62	57	53	49	46	44	41	39	37							
TUD1C100A9601A								62	57	53	49	46	44	41	39	37	35	34	32	31			
TUD1D100A9721A								62	57	53	49	46	44	41	39	37	35	34	32	31			
TUD1C120A9541A										63	59	56	52	49	47	44	42	40					
TUD1D120A9601A											59	56	52	49	47	44	42	40					
TUD1D140A9601A												69	65	61	58	55	52	49	47	45			



**TRANE®**

# Field Wiring

## FIELD WIRING DIAGRAM FOR HEATING ONLY

**NOTES**

1. BE SURE POWER SUPPLY AGREES WITH EQUIPMENT NAMEPLATE(S).
2. LOW VOLTAGE (24V.) WIRING TO BE NO. 18 A.W.G. MIN.
3. GROUNDING OF EQUIPMENT MUST COMPLY WITH LOCAL CODES.
4. SET THERMOSTAT HEAT ANTICIPATOR PER UNIT WIRING DIAGRAM.
5. 24V COMMON CONNECTION MAY BE REQUIRED FOR USE WITH ELECTRONIC THERMOSTATS.

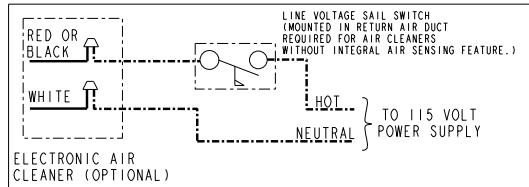
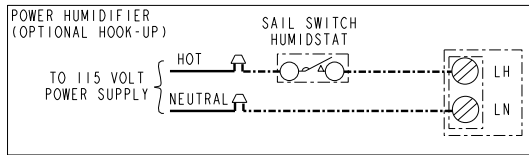

**INTER-COMPONENT WIRING**

----- 24 V. } FIELD WIRING  
 - - - - - LINE V. }

===== 24 V. } FACTORY WIRING  
 ===== LINE V. }

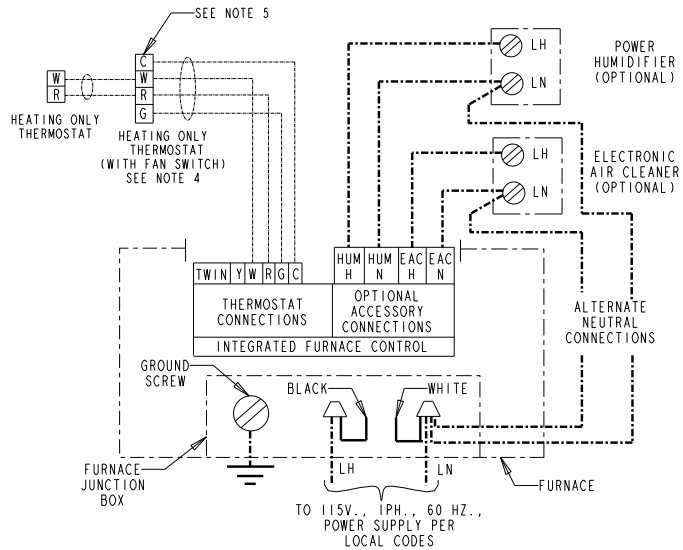

From Dwg.. 21B341437 Rev. 1

## FIELD WIRING DIAGRAM FOR SINGLE STAGE HEATING/COOLING (OUTDOOR SECTION WITHOUT TRANSFORMER)

**NOTES**

1. BE SURE POWER SUPPLY AGREES WITH EQUIPMENT NAMEPLATE(S).
2. LOW VOLTAGE (24V.) WIRING TO BE NO. 18 A.W.G. MIN.
3. GROUNDING OF EQUIPMENT MUST COMPLY WITH LOCAL CODES.
4. SET THERMOSTAT HEAT ANTICIPATOR PER UNIT WIRING DIAGRAM.
5. THE "Y" TERMINAL FROM THE THERMOSTAT MUST BE WIRED TO THE "Y" TERMINAL OF THE FURNACE CONTROL FOR PROPER BLOWER OPERATION DURING COOLING.
6. 24V COMMON CONNECTION MAY BE REQUIRED FOR USE WITH ELECTRONIC THERMOSTATS.

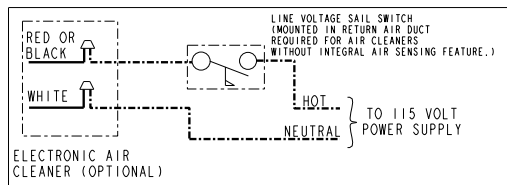
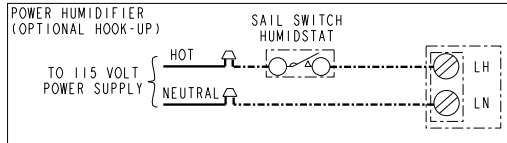

**INTER-COMPONENT WIRING**

----- 24 V. } FIELD WIRING  
 - - - - - LINE V. }

===== 24 V. } FACTORY WIRING  
 ===== LINE V. }

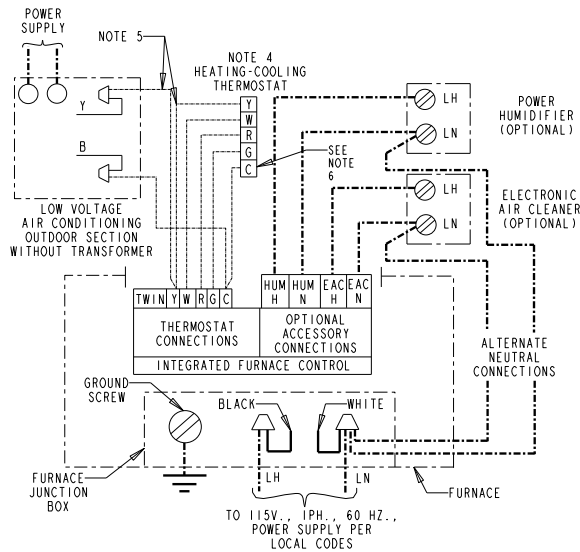

From Dwg.. 21B341436 Rev. 1

# Field Wiring

**TWINNING CONNECTION DIAGRAM  
FOR TWINNING 1 STAGE FURNACES  
WITH SINGLE WIRE TWINNING FEATURE  
1 STAGE HEATING ONLY THERMOSTAT**

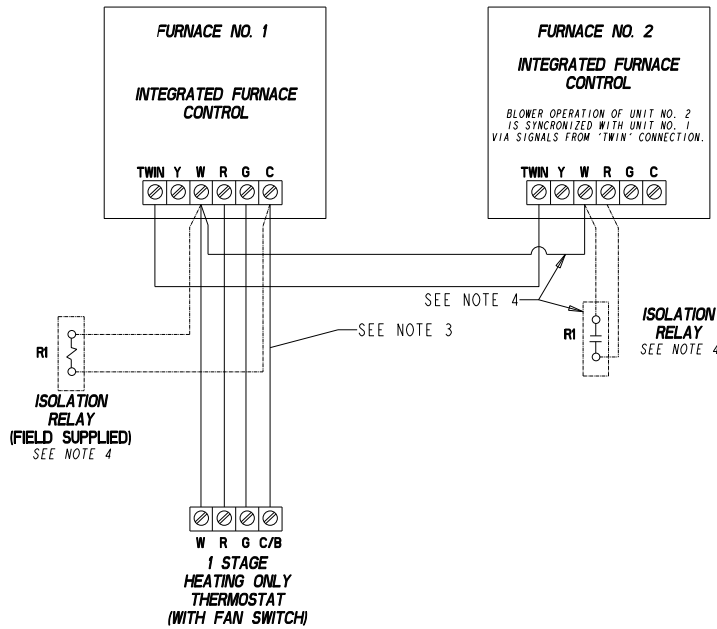

**NOTES:**

- 1.) BOTH FURNACES MUST BE POWERED FROM THE SAME 115V. LEG OF CIRCUIT PANEL.
- 2.) INSURE 24V. FURNACE TRANSFORMERS ARE IN PHASE. PRIOR TO COMPLETING CONNECTIONS, CHECK VOLTAGE BETWEEN "R" TERMINALS OF EACH FURNACE. IF VOLTAGE IS GREATER THAN 10V., REVERSE THE BL AND RD SECONDARY LEADS ON ONE OF THE FURNACE TRANSFORMERS.
- 3.) CONNECTION MAY BE REQUIRED FOR ELECTRONIC THERMOSTAT.
- 4.) IF CURRENT EXCEEDS THERMOSTAT CURRENT RATING, USE ISOLATION RELAYS ("RI") AS SHOWN. (DO NOT CONNECT W TO W) ISOLATION RELAY NOT NEEDED IF THE THERMOSTAT CONTACTS ARE RATED AT 1.0A. OR ABOVE.

----- ALTERNATE WIRING CONFIGURATION  
SEE NOTE 4.

From Dwg.. 21B341422 Rev. 1

**TWINNING CONNECTION DIAGRAM  
FOR TWINNING 1 STAGE FURNACES  
WITH SINGLE WIRE TWINNING FEATURE  
1 STAGE HEAT / 1 STAGE COOLING THERMOSTAT**

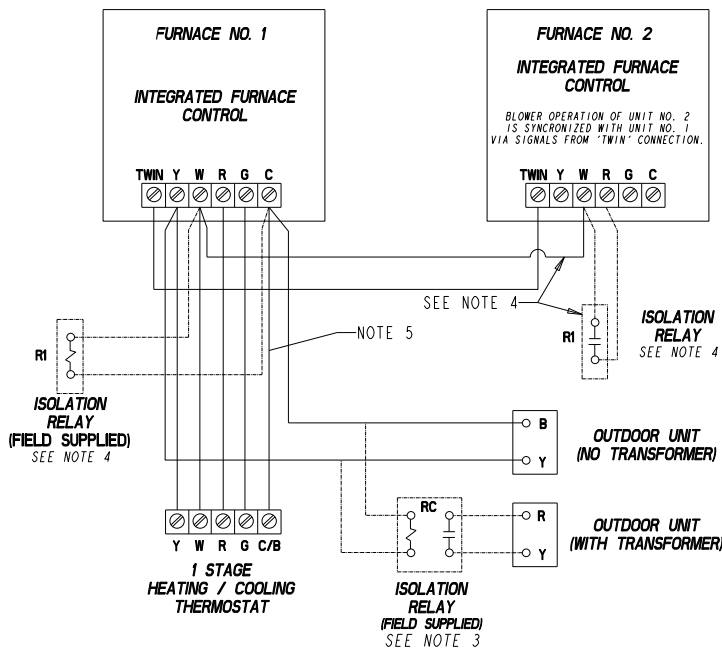

**NOTES:**

- 1.) BOTH FURNACES MUST BE POWERED FROM THE SAME 115V. LEG OF CIRCUIT PANEL.
- 2.) INSURE 24V. FURNACE TRANSFORMERS ARE IN PHASE. PRIOR TO COMPLETING CONNECTIONS, CHECK VOLTAGE BETWEEN "R" TERMINALS OF EACH FURNACE. IF VOLTAGE IS GREATER THAN 10V., REVERSE THE BL AND RD SECONDARY LEADS ON ONE OF THE FURNACE TRANSFORMERS.
- 3.) IF OUTDOOR UNIT HAS A 24V. TRANSFORMER, AN ISOLATION RELAY MUST BE INSTALLED. (FIELD SUPPLIED - USE PILOT DUTY RELAY ("RC"), SUCH AS RLY0975.) SEE ALT. CONNECTION.
- 4.) IF CURRENT EXCEEDS THERMOSTAT CURRENT RATING, USE ISOLATION RELAYS ("RI") AS SHOWN. (DO NOT CONNECT W TO W) ISOLATION RELAY NOT NEEDED IF THE THERMOSTAT CONTACTS ARE RATED AT 1.0A. OR ABOVE.
- 5.) CONNECTION MAY BE REQUIRED FOR ELECTRONIC THERMOSTATS.

----- ALTERNATE WIRING CONFIGURATION  
SEE NOTE 4.

From Dwg.. 21B341423 Rev. 1



**TRANE®**

# Dimensions

## TUD1 OUTLINE DRAWING (ALL DIMENSIONS ARE IN INCHES)

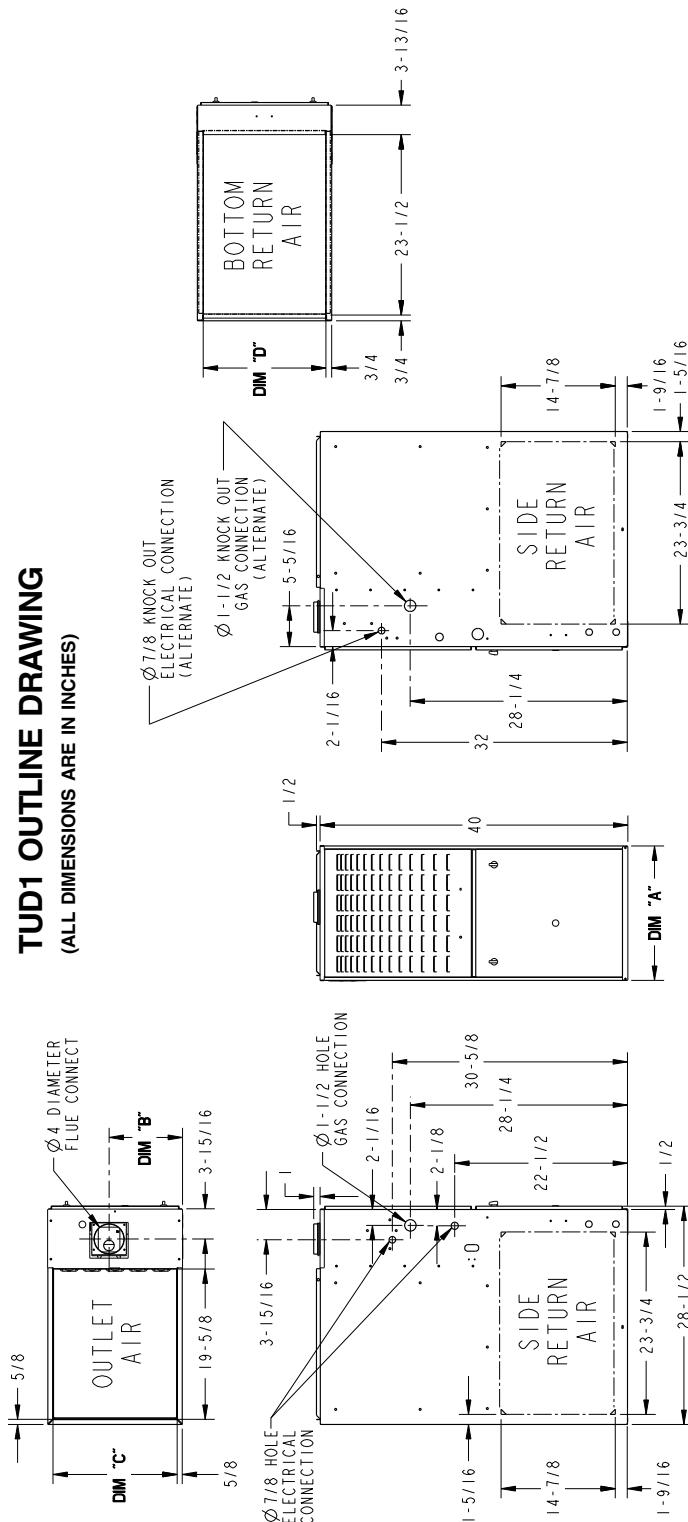

MINIMUM CLEARANCE TO COMBUSTIBLE MATERIALS	
UPFLOW CLOSET	FRONT 3 IN. (SEE NOTE 1) LEFT SIDE 0 IN. BACK 0 IN. RIGHT SIDE #6 IN. TOP 1 IN. FLUE
HORIZONTAL CLOSET (SEE NOTE 2)	FRONT #2 IN. BACKS 3 IN. TOP #2 IN. (SEE NOTE 1) FRONT 18 IN. (SEE NOTE 1)
HORIZONTAL ALCOVE (SEE NOTE 2)	FRONT #1 IN. BACK 0 IN. FLUE #6 IN. SIDES 0 IN. TOP 18 IN.

\* MAY BE 1" WHEN TYPE B-1 VENT IS USED  
 \* FOR 14-1/2" CABINETS 3" WHEN SINGLE WALL VENT PIPE IS USED.  
 WHEN 14-1/2" CABINETS (ALL #UD040C, #UD040R, #UD060C, AND #UD060R936) ARE INSTALLED IN A HORIZONTAL POSITION AND A SINGLE WALL VENT PIPE IS USED, 1/2" CLEARANCE MUST BE SUPPLIED BETWEEN THE VENT PIPE AND COMBUSTIBLE FLOORING.

NOTES:  
 1) MINIMUM CLEARANCE TO FRONT ON #UD140R960 AND #UD140C960 IS 6 INCHES.  
 2) MUST BE INSTALLED ON COMBUSTIBLE FLOOR WHEN TYPE B-1 VENT IS USED.

MODEL	DIM "A"	DIM "B"	DIM "C"	DIM "D"
TUD1A040C924A	14-1/2"	9-5/8"	13-1/4"	13"
TUD1A040C930A				
TUD1A060C924A	17-1/2"	9-5/8"	16-1/4"	16"
TUD1A060C936A				
TUD1B060A936A				
TUD1B080C924A	21"	13-1/16"	19-3/4"	19-1/2"
TUD1B080C936A				
TUD1B080C948A				
TUD1B100C936A	24-1/2"	15-5/16"	23-1/4"	23"
TUD1B100C945A				
TUD1C080C960A				
TUD1C100C948A				
TUD1C100C960A				
TUD1C120C954A				
TUD1D100C972A				
TUD1D120C960A				
TUD1D140C960A				

\* PREFIX LETTER MAY BE "A" OR "T."  
 \*\* SUFFIX LETTERS MAY BE "K" TO THROUGH 9)

# Electrical Data

## WIRING DIAGRAM FOR GAS FURNACES

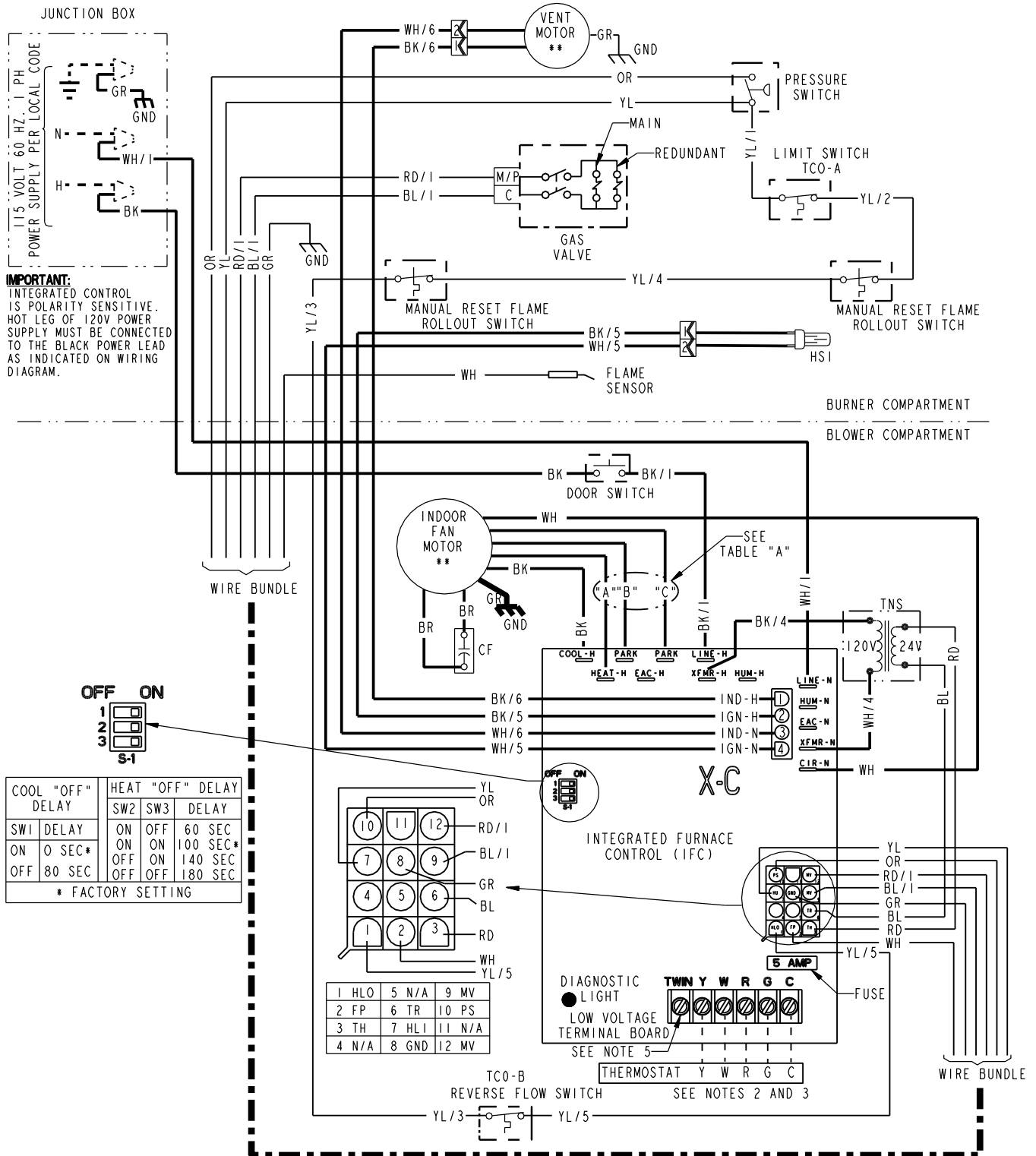

# SCHEMATIC DIAGRAM FOR GAS FURNACES

115 VOLT 60 HZ. 1 PH  
POWER SUPPLY PER LOCAL CODE

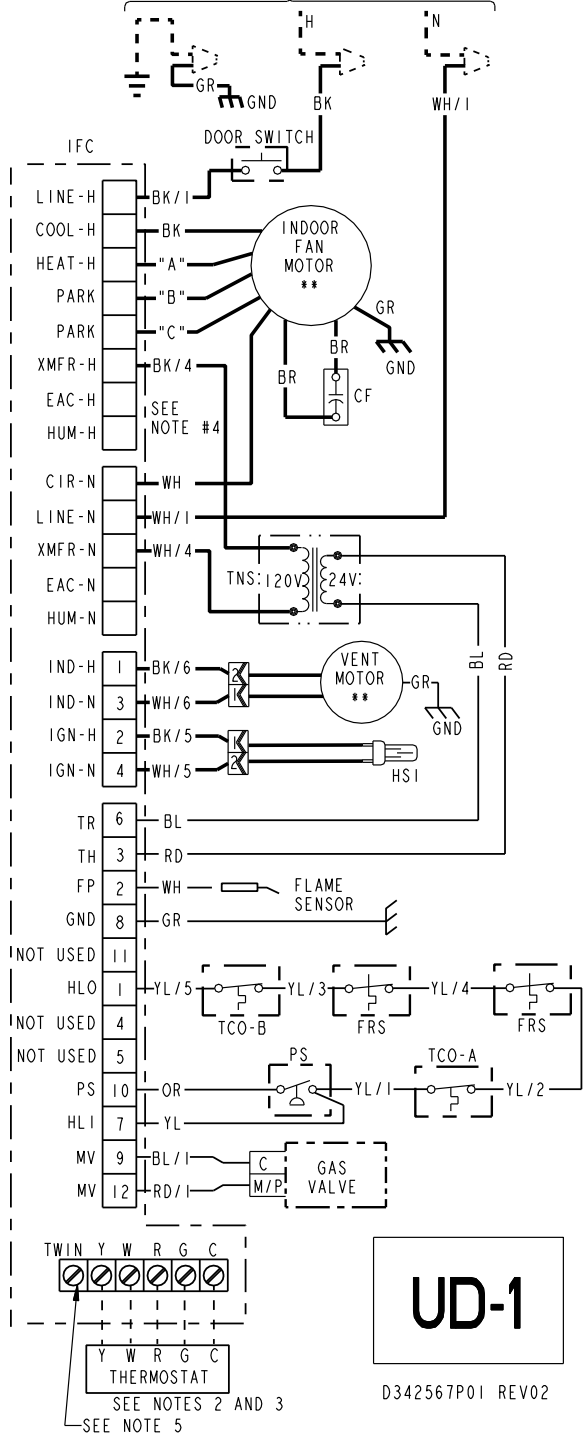

MODEL	HEAT "A"	PARK "B"	PARK "C"
*UD1A040A9241##	YL	RD	BL
*UD1A040A9301##	RD	BL	YL
*UD1A060A9241##	BL	RD	YL
*UD1A060A9361##	YL	RD	BL
*UD1B060A9361##	RD	BL	YL
*UD1B080A9241##	BL	RD	YL
*UD1B080A9361##	BL	RD	YL
*UD1B080A9481##	BL	RD	YL
*UD1C080A9601##	RD	BL	YL
*UD1B100A9361##	BL	RD	YL
*UD1B100A9451##	BL	RD	YL
*UD1C100A9481##	BL	RD	YL
*UD1C100A9601##	YL	BL	RD
*UD1D100A9721##	RD	YL	BK
*UD1C120A9541##	BL	RD	YL
*UD1D120A9601##	BL	RD	YL
*UD1D140A9601##	BL	RD	YL

\* PREFIX MAY BE "A" OR "T"  
# SUFFIX MAY BE "A" THROUGH "Z"  
RD = LOW BL = MED. HIGH  
YL = MED. LOW BK = HIGH

**WARNING**  
HAZARDOUS VOLTAGE:  
DISCONNECT ALL ELECTRICAL POWER INCLUDING REMOTE DISCONNECTS BEFORE SERVICING.  
FAILURE TO DISCONNECT POWER BEFORE SERVICING CAN CAUSE SEVERE PERSONAL INJURY OR DEATH.

**CAUTION**  
USE COPPER CONDUCTORS ONLY!  
UNIT TERMINALS ARE NOT DESIGNED TO ACCEPT OTHER TYPES OF CONDUCTORS.  
FAILURE TO DO SO MAY CAUSE DAMAGE TO THE EQUIPMENT.

**INTEGRATED FURNACE CONTROL**  
REPLACE WITH PART CNT03076 OR EQUIVALENT  
INPUT: 25 VAC, 60 HZ.  
XFMR SEC. CURRENT: 450 MA.  
MV OUTPUT: 1.5 A @ 24 VAC  
IND OUTPUT: 2.2 FLA, 3.5 LRA @ 120 VAC  
CIRC. BLOWER OUTPUT: 14.5 FLA, 26 LRA @ 120 VAC  
HUMIDIFIER & AIR CLEANER  
MAX. LOAD: 1.0 A @ 120 VAC  
IGNITER OUTPUT: 2.0 A @ 120 VAC

### DIAGNOSTIC CODES

FLASHING SLOW: NORMAL - NO CALL FOR HEAT  
FLASHING FAST: NORMAL - CALL FOR HEAT  
CONTINUOUS ON: REPLACE IFC  
CONTINUOUS OFF: CHECK POWER  
2 FLASHES: EXTERNAL LOCKOUT (RETRIES OR RECYCLES EXCEEDED)  
3 FLASHES: PRESSURE SWITCH ERROR  
4 FLASHES: OPEN LIMIT DEVICE  
5 FLASHES: FLAME SENSED WHEN NO FLAME SHOULD BE PRESENT  
6 FLASHES: 115 VAC POWER REVERSED POLARITY OR POOR GROUNDING  
7 FLASHES: GAS VALVE CIRCUIT ERROR  
8 FLASHES: LOW FLAME SENSE SIGNAL  
9 FLASHES: CHECK IGNITER

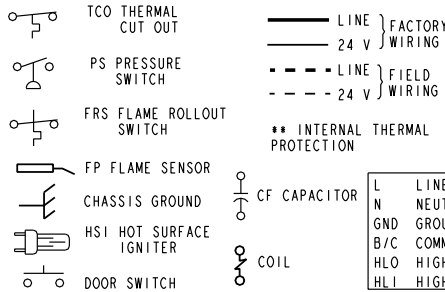

BK	BLACK	GR	GREEN
WH	WHITE	BR	BROWN
YL	YELLOW	RD	RED
OR	ORANGE	BL	BLUE

WIRE COLOR  
BK/1 NUMBER ID (IF ANY)

L	LINE	TH	24 VAC (HOT)
N	NEUTRAL	TR	24 VAC (COMMON)
GND	GROUND	MV	MAIN GAS VALVE
B/C	COMMON	TNS	TRANSFORMER
HLO	HIGH LIMIT OUTPUT		
HLI	HIGH LIMIT INPUT		

### NOTES:

- IF ANY OF THE ORIGINAL WIRING AS SUPPLIED WITH THIS FURNACE MUST BE REPLACED, IT MUST BE WITH WIRE HAVING A TEMPERATURE RATING OF AT LEAST 105 C.
- THERMOSTAT HEAT ANTICIPATOR SETTING: .38 AMPS
- FOR PROPER OPERATION OF COOLING SPEED, "Y" TERMINAL MUST BE CONNECTED TO THE ROOM THERMOSTAT.
- THESE TERMINALS PROVIDE 120V POWER CONNECTIONS FOR ELECTRONIC AIR CLEANER (EAC) AND HUMIDIFIER (HUM). MAX. LOAD: 1.0 AMPS EACH.
- WHEN TWINNING TWO FURNACES, BOTH UNITS MUST BE CONNECTED TO THE SAME 115 VAC PHASE. CONNECT THE TWO UNITS 'TWIN' TERMINALS WITH 14 TO 22 AWG. WIRE.



Trane  
6200 Troup Highway  
Tyler, TX 75707  
www.trane.com

Since Trane has a policy of continuous product and product data improvement, it reserves the right to change design and specifications without notice.